

BRIVILOR[®]
BONAMAT

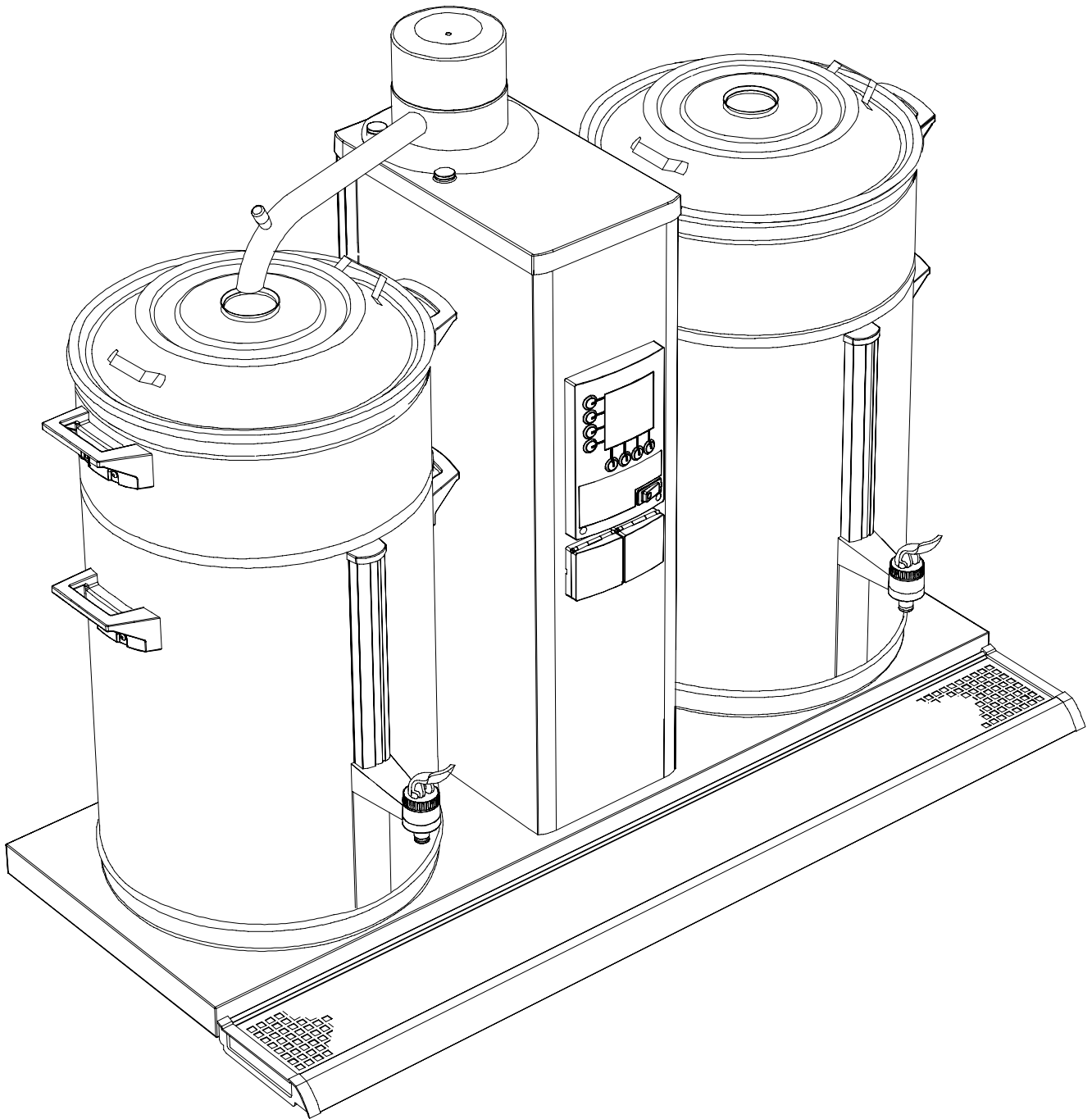

























Operating instructions
Photos

ROUND FILTER COFFEE BREWER



B-series

700.403.800

	English	Türkçe	Español	日本語	한글	中文
1.	 Use	Kullanım	Uso	使用	사용	使用
	 Dripping	Damlama	Goteo	滴	추출	滴水
2.	 Cleaning, frequently	Temizleme, sık sık	Limpieza frecuente	滴	꽃은 청소	清潔・次數
	 Wait	Bekleme	Espera	お待ちください	대기	等候
	 Acoustic signal	Sesli sinyal	Señal acústico	音信号	신호음	聽覺信號
3.	 Descaling	Kireçten Arındırma	Descalificar	スケール除去	스케일 제거	清除水垢
	 Read Operating Instructions	Kullanma Talimatini Oku	Lea instrucciones de uso	取扱説明書参照	취급설명서 참조	閱讀操作說明
4.	 Initial use	İlk kullanım	Uso inicial	使い初め	사용 초기	初次使用
5.	 Programming (operator)	Programlama (operatör)	Programación (operador)	(ユーザー)プログラミング	사용자 프로그래밍	程式(操作)
	 Selection keys	Seçme düğmeleri	Tecla de selección	選択ボタン	선택 키	選擇按鍵
	 Confirm	Onayla	Confirmar	確定	확정	確定
	 Cancel	İptal	Cancelar	キャンセル	취소	取消
	 Water hardness	Suyun sertliği	Dureza de agua	水硬度	수질 경도	水的硬度
	 Read Operating Instructions	Kullanma Talimatini Oku	Lea instrucciones de uso	取扱説明書参照	취급설명서 참조	閱讀操作說明
6.	 Programming (principal)	Programlama (esas)	Programación (principal)	(主要な)プログラミング	프로그래밍(원리)	程式(主要的)
	 Selection keys	Seçme düğmeleri	Tecla de selección	選択ボタン	선택 키	選擇按鍵
	 Confirm	Onayla	Confirmar	確定	확정	確定
	 Cancel	İptal	Cancelar	キャンセル	취소	取消
	 Off	Kapalı	Apagado	オフ	오프	關閉
	 Min.	En Az	Min.	最小	최소	最小
	 Standard	Standart	Estándar	標準	표준	標準
	 Max.	En Fazla	Max.	最大	최대	最大
	 Water hardness	Suyun sertliği	Dureza de agua	水硬度	수질 경도	水的硬度
	 Read Operating Instructions	Kullanma Talimatini Oku	Lea instrucciones de uso	取扱説明書参照	취급설명서 참조	閱讀操作說明
	 Hold 10 sec.	10 san. Tut	Aguante 10 Segundos	10秒待機	10초간 대기	按著10秒
 Select desired time setting (1-14)	Istenilen zaman ayarini sec (1-14)	Selecciona tiempo deseado (1-14)	時間設定(1-14)の選択	시간설정(1-14)의 선택	選擇所需時間設定(1-14)	
7.	 Error codes	Arıza Kod	Códigos de mal función	エラーコード	에러 코드	錯誤的編號

1. USE (B)

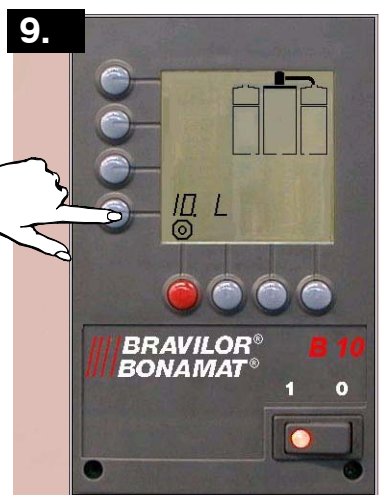
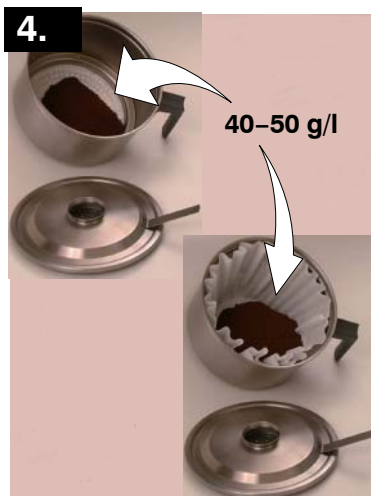
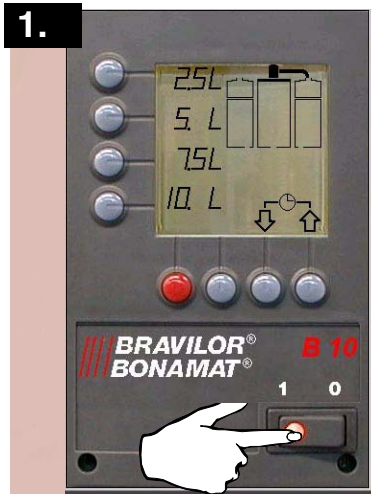

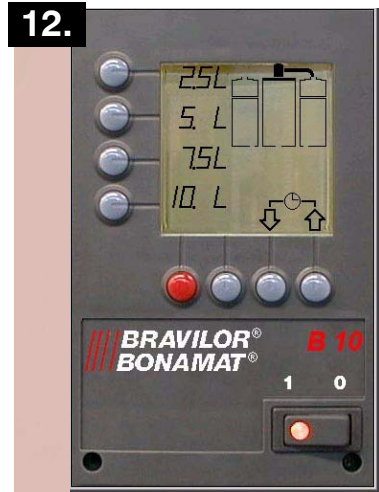

2. CLEANING, FREQUENTLY (B)

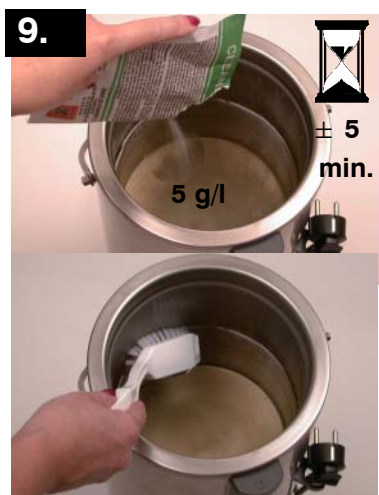
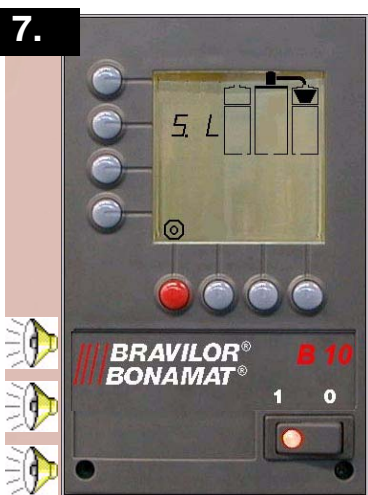
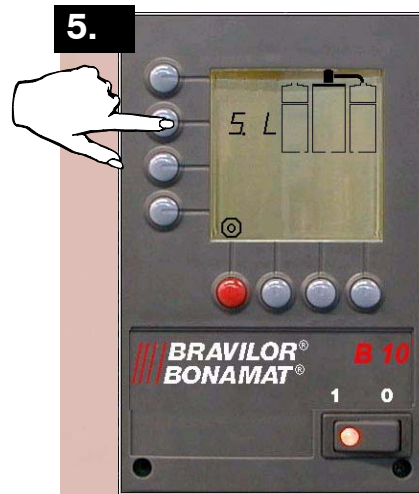
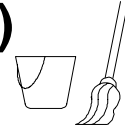

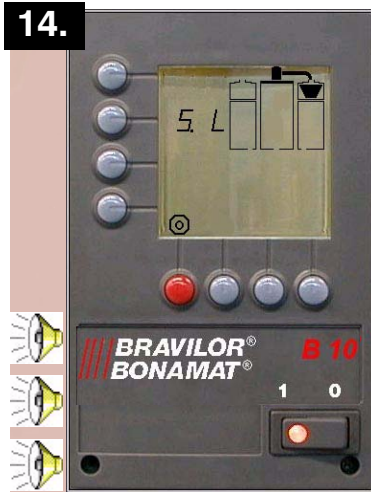



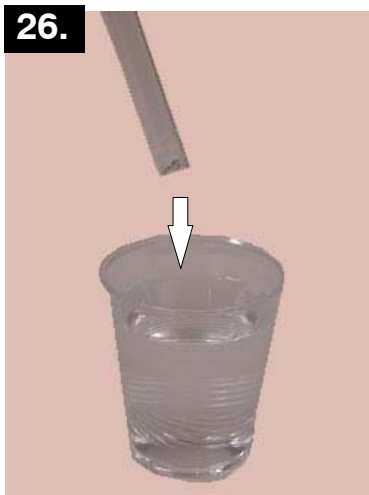

3. DESCALING (B) ± 30 MIN. (OPERATOR)

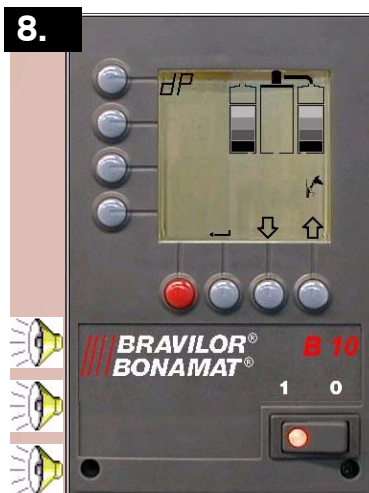
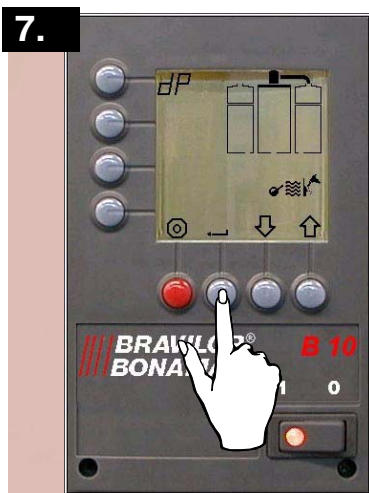
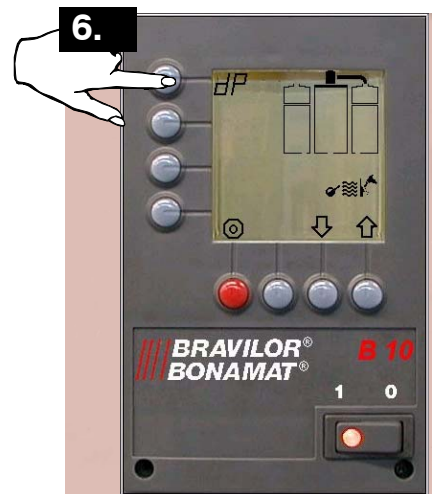
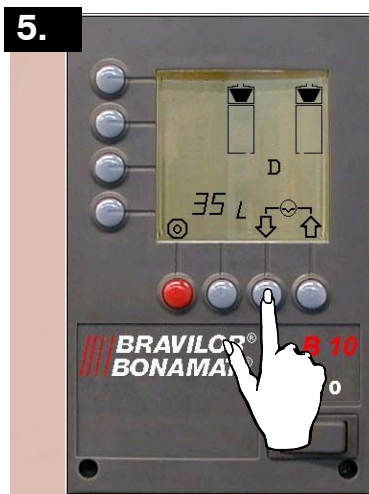
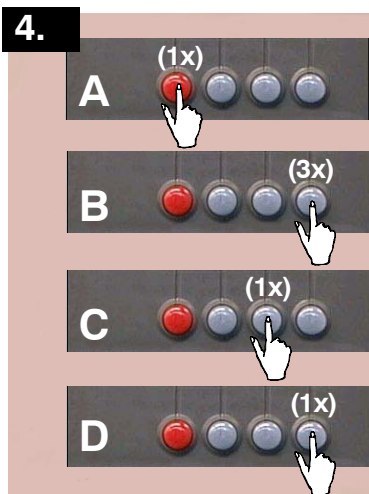
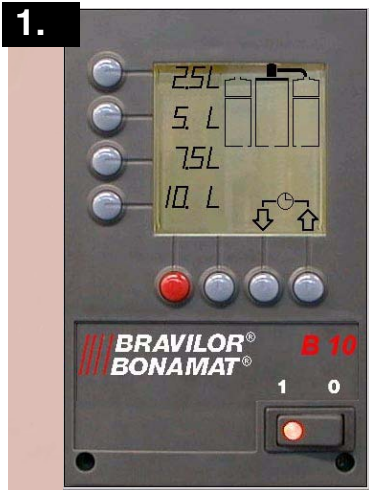

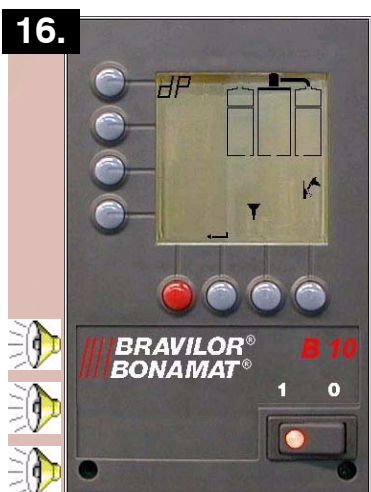
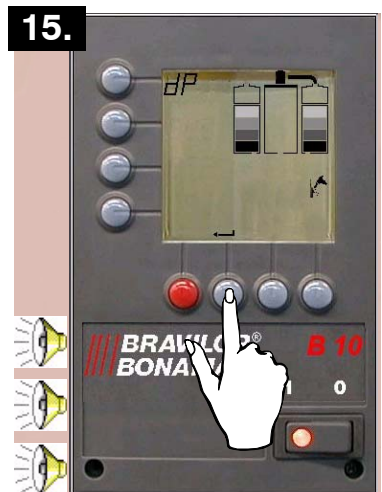
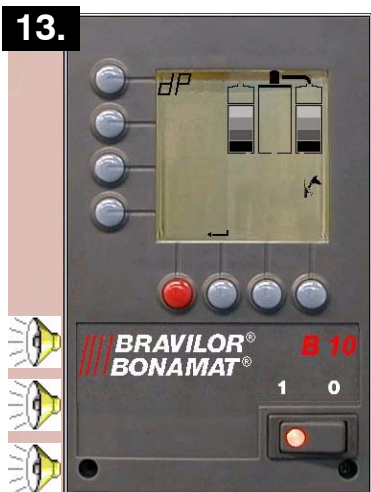
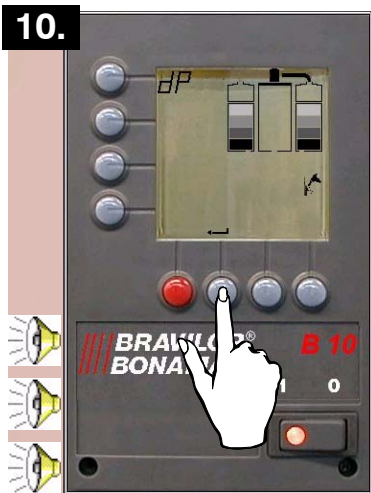

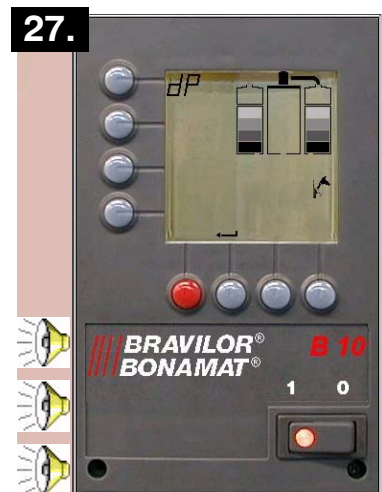
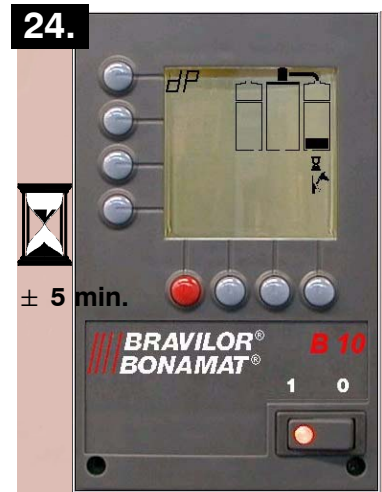
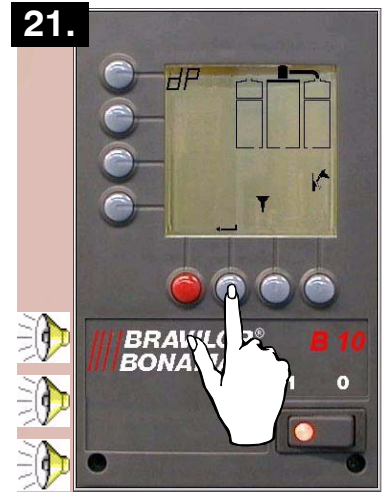

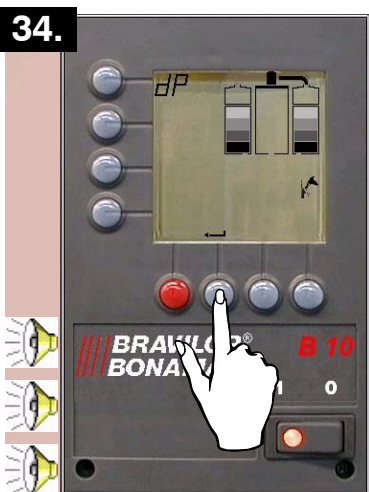
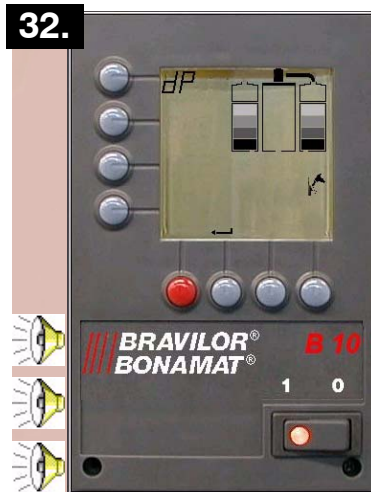
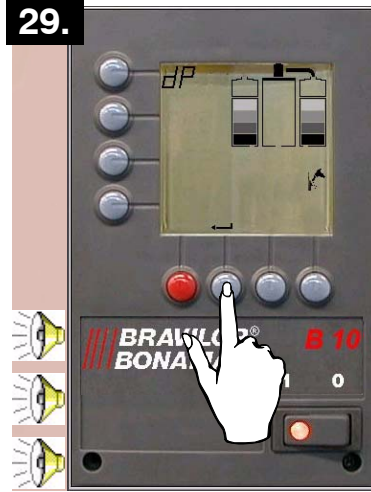

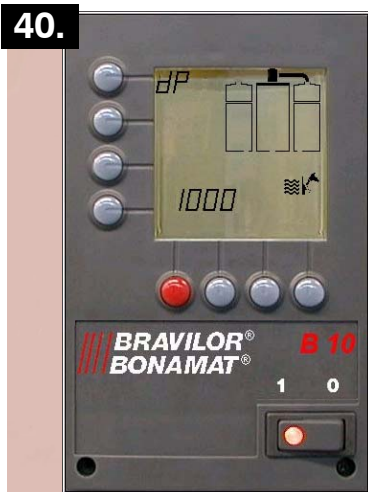
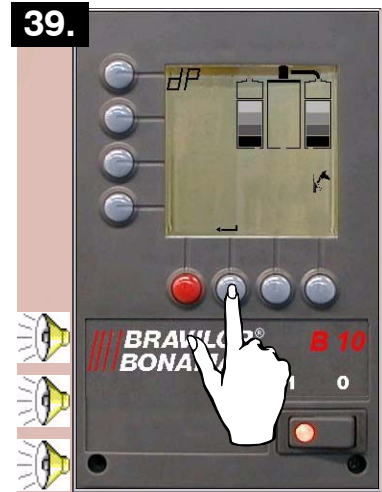
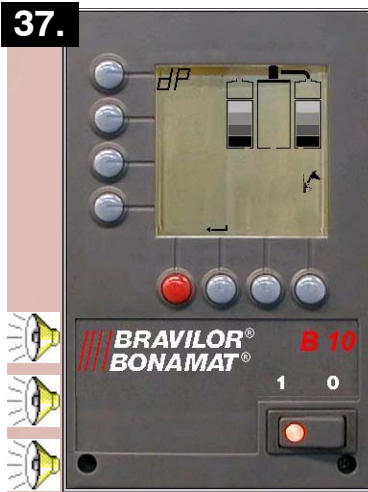

4. INITIAL USE (B)

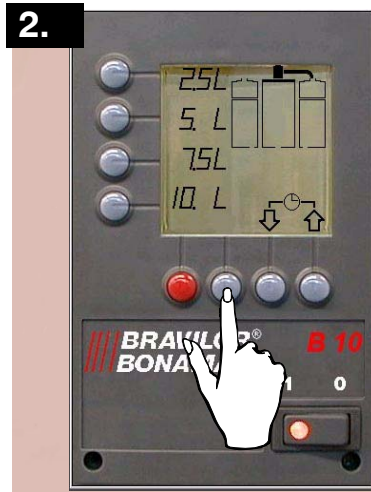
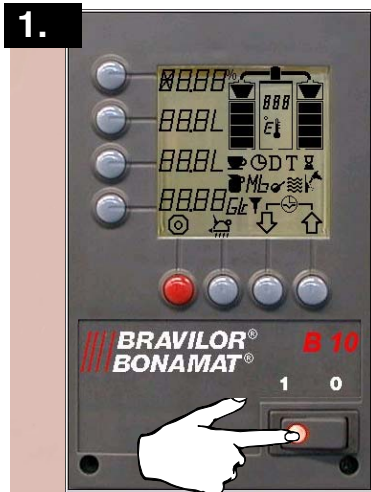

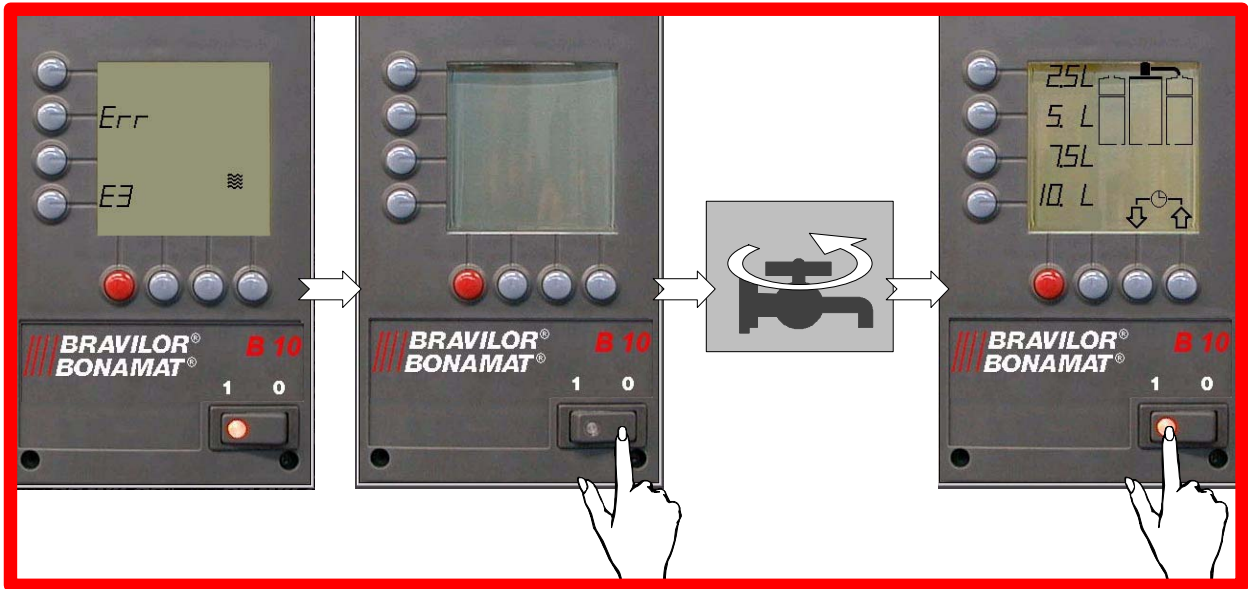









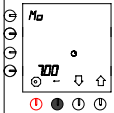
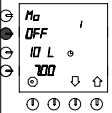

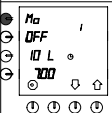
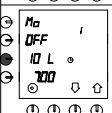
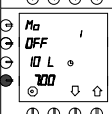
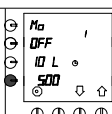

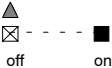



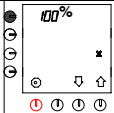

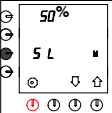

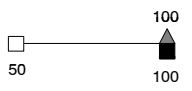

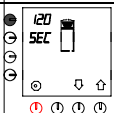

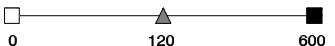

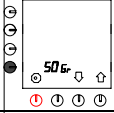



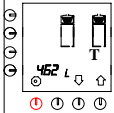

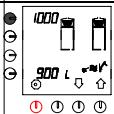
5. PROGRAMMING (B) (OPERATOR)

				= 0	
				§ 3.	

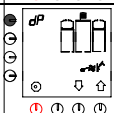
6. PROGRAMMING (B) (PRINCIPAL USER)

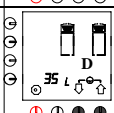
				<table border="1"> <tr><td>B5</td><td>4.8</td><td>5.3</td><td>5.8</td></tr> <tr><td>B10</td><td>10.6</td><td>9.6</td><td>11.6</td></tr> <tr><td>B20</td><td>19.2</td><td>21.2</td><td>23.2</td></tr> <tr><td>B40</td><td>38.4</td><td>42.4</td><td>46.4</td></tr> </table>	B5	4.8	5.3	5.8	B10	10.6	9.6	11.6	B20	19.2	21.2	23.2	B40	38.4	42.4	46.4																																																																																																						
B5	4.8	5.3	5.8																																																																																																																							
B10	10.6	9.6	11.6																																																																																																																							
B20	19.2	21.2	23.2																																																																																																																							
B40	38.4	42.4	46.4																																																																																																																							
				<table border="1"> <tr><td>B5</td><td>1</td><td>1</td><td>3</td><td>4</td><td>5</td><td>5</td></tr> <tr><td>B10</td><td>2</td><td>2.5</td><td>5</td><td>7.5</td><td>10</td><td>10</td></tr> <tr><td>B20</td><td>4</td><td>5</td><td>10</td><td>15</td><td>20</td><td>20</td></tr> <tr><td>B40</td><td>8</td><td>10</td><td>20</td><td>30</td><td>40</td><td>40</td></tr> </table> <table border="1"> <tr><td>50</td><td>125</td><td>200</td></tr> </table> <table border="1"> <tr><td>B5</td><td>8</td><td>8</td><td>24</td><td>32</td><td>40</td><td>40</td></tr> <tr><td>B10</td><td>20</td><td>20</td><td>40</td><td>60</td><td>80</td><td>80</td></tr> <tr><td>B20</td><td>40</td><td>40</td><td>80</td><td>120</td><td>160</td><td>160</td></tr> <tr><td>B40</td><td>80</td><td>80</td><td>160</td><td>240</td><td>320</td><td>320</td></tr> </table> <table border="1"> <tr><td>50</td><td>250</td><td>3000</td></tr> </table> <table border="1"> <tr><td>B5</td><td>4</td><td>4</td><td>12</td><td>16</td><td>20</td><td>20</td></tr> <tr><td>B10</td><td>10</td><td>10</td><td>20</td><td>30</td><td>40</td><td>40</td></tr> <tr><td>B20</td><td>20</td><td>20</td><td>40</td><td>60</td><td>80</td><td>80</td></tr> <tr><td>B40</td><td>40</td><td>40</td><td>80</td><td>120</td><td>160</td><td>160</td></tr> </table> <table border="1"> <tr><td>B5</td><td>0.30</td><td>0.30</td><td>0.65</td><td>0.95</td><td>1.30</td><td>1.30</td></tr> <tr><td>B10</td><td>0.65</td><td>0.65</td><td>1.30</td><td>1.95</td><td>2.60</td><td>2.60</td></tr> <tr><td>B20</td><td>1.30</td><td>1.30</td><td>2.60</td><td>3.95</td><td>5.25</td><td>5.25</td></tr> <tr><td>B40</td><td>2.60</td><td>2.60</td><td>5.25</td><td>7.90</td><td>10.55</td><td>10.55</td></tr> </table>	B5	1	1	3	4	5	5	B10	2	2.5	5	7.5	10	10	B20	4	5	10	15	20	20	B40	8	10	20	30	40	40	50	125	200	B5	8	8	24	32	40	40	B10	20	20	40	60	80	80	B20	40	40	80	120	160	160	B40	80	80	160	240	320	320	50	250	3000	B5	4	4	12	16	20	20	B10	10	10	20	30	40	40	B20	20	20	40	60	80	80	B40	40	40	80	120	160	160	B5	0.30	0.30	0.65	0.95	1.30	1.30	B10	0.65	0.65	1.30	1.95	2.60	2.60	B20	1.30	1.30	2.60	3.95	5.25	5.25	B40	2.60	2.60	5.25	7.90	10.55	10.55
B5	1	1	3	4	5	5																																																																																																																				
B10	2	2.5	5	7.5	10	10																																																																																																																				
B20	4	5	10	15	20	20																																																																																																																				
B40	8	10	20	30	40	40																																																																																																																				
50	125	200																																																																																																																								
B5	8	8	24	32	40	40																																																																																																																				
B10	20	20	40	60	80	80																																																																																																																				
B20	40	40	80	120	160	160																																																																																																																				
B40	80	80	160	240	320	320																																																																																																																				
50	250	3000																																																																																																																								
B5	4	4	12	16	20	20																																																																																																																				
B10	10	10	20	30	40	40																																																																																																																				
B20	20	20	40	60	80	80																																																																																																																				
B40	40	40	80	120	160	160																																																																																																																				
B5	0.30	0.30	0.65	0.95	1.30	1.30																																																																																																																				
B10	0.65	0.65	1.30	1.95	2.60	2.60																																																																																																																				
B20	1.30	1.30	2.60	3.95	5.25	5.25																																																																																																																				
B40	2.60	2.60	5.25	7.90	10.55	10.55																																																																																																																				
				<table border="1"> <tr><td>88</td><td>97</td><td>97</td></tr> </table> <table border="1"> <tr><td>190</td><td>206</td><td>206</td></tr> </table>	88	97	97	190	206	206																																																																																																																
88	97	97																																																																																																																								
190	206	206																																																																																																																								
				<p>▲ EnG</p> <p>□ ■ dEu, FrA, ESP, nEd</p> <p>▲ ☒ - - - - - ■ off on</p>																																																																																																																						

			Select desired time setting (1-14). 						 off on
									
									
									
									
									
									
									§ 3. (Operator)
									= 0

7. ERROR CODES (B)

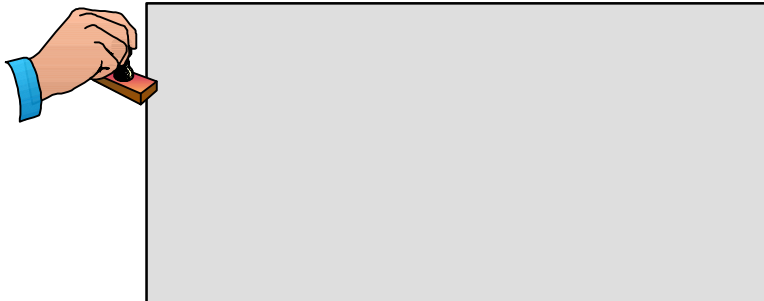
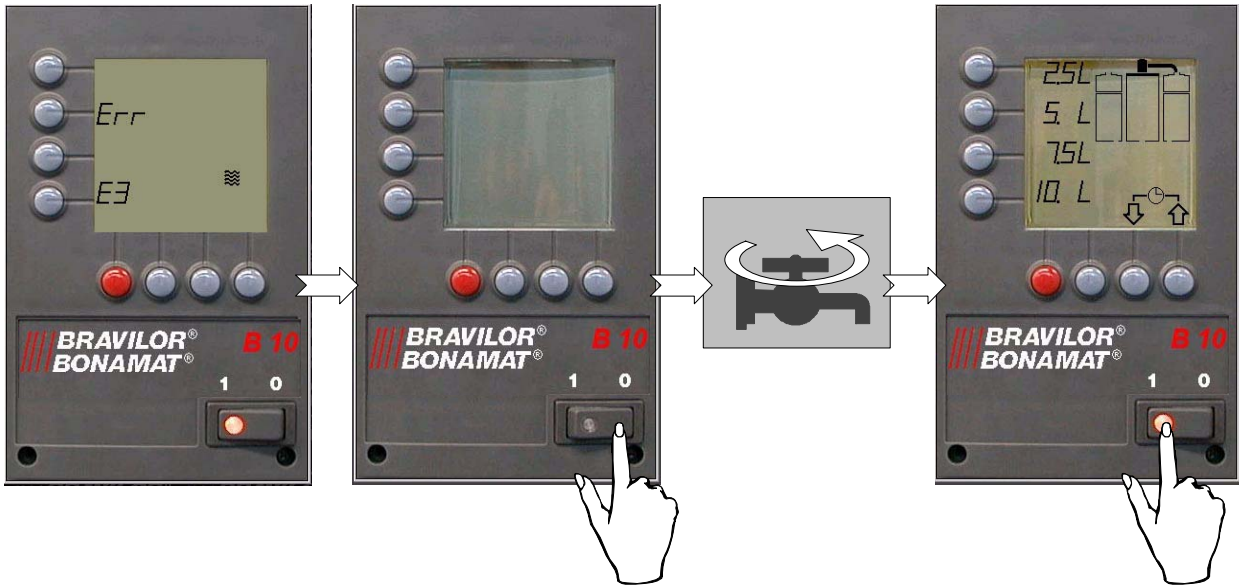



**/// BRAVILOR[®]
BONAMAT**

COFFEE BREWING MACHINES
MACHINES A CAFE
KAFFEEBRUEHMASCHINEN
KOFFIEZETAPPARATEN

© 11-2001

700.403.800